



ZONA[®]
GLASS OFFICE FRONTS

CUSTOMIZED FUNCTION, AESTHETIC CONSISTENCY

SEPARATE SPACE IN **STYLE**

Why ZONA?

ZONA Glass Wall Systems offer a minimal yet sharp profile to maximize daylighting capabilities. All product lines keep a consistent 1 1/2" profile, integrating seamlessly throughout the ZONA product families and are available in a vast array of finishes, sizes, and configurations. Our systems use proprietary solid steel blocks at all stress points while allowing for customization to meet all project needs. All systems have gone through rigorous testing by an independent certified lab for sound transmission, rigidity, and finish durability.

Proudly made in the USA, all ZONA Glass Wall Systems come with comprehensive 5-year warranty, providing peace of mind for long-term performance reliability.



System Thresholds

Product Specifications

Single Glazed Systems

FIXED GLASS THICKNESS	$\frac{3}{8}$ " , $\frac{1}{2}$ " or $\frac{5}{8}$ "
SYSTEM DEPTH	$1 \frac{3}{8}$ " or 2"
CORNER CONFIGURATION	Aluminum Post, Mitered Glass
INTERSECTIONS	Fly-by Post, Glass "T" Connections
MAX. FLOOR VARIANCE	$\frac{3}{8}$ " (Non-cumulative)



ZONA 1



ZONA 1+

Double Glazed Systems

FIXED GLASS THICKNESS	$\frac{3}{8}$ " , $\frac{1}{2}$ " or $\frac{5}{8}$ "
SYSTEM DEPTH	$3 \frac{1}{4}$ " , 4" or Custom
CORNER CONFIGURATION	Aluminum Post, Mitered Glass
INTERSECTIONS	Fly-by Post, Glass "T" Connections
MAX. FLOOR VARIANCE	$\frac{3}{8}$ " (Non-cumulative)



ZONA 2



ZONA 2+

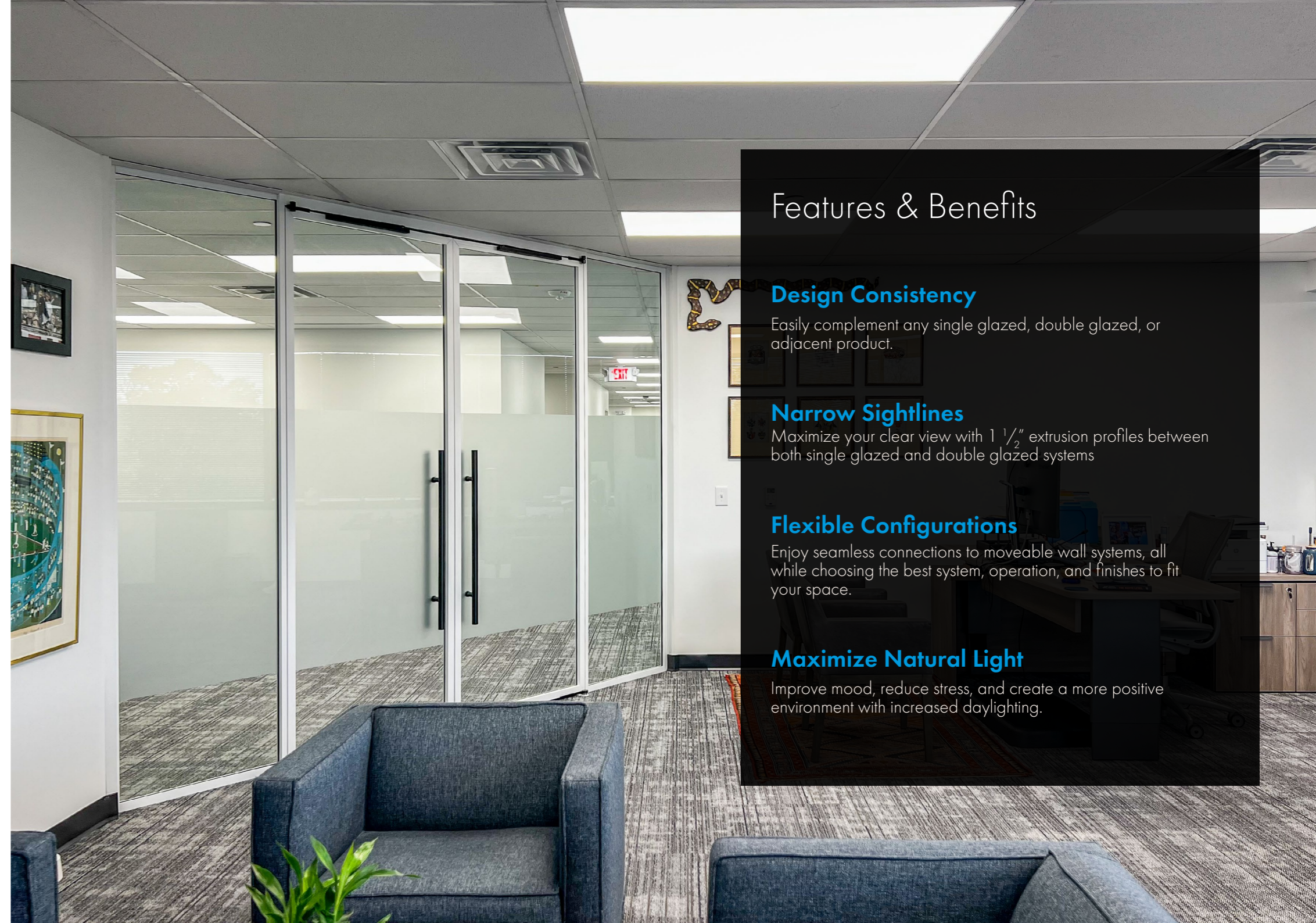

Features & Benefits

Design Consistency

Easily complement any single glazed, double glazed, or adjacent product.

Narrow Sightlines

Maximize your clear view with $1 \frac{1}{2}$ " extrusion profiles between both single glazed and double glazed systems

Flexible Configurations

Enjoy seamless connections to moveable wall systems, all while choosing the best system, operation, and finishes to fit your space.

Maximize Natural Light

Improve mood, reduce stress, and create a more positive environment with increased daylighting.

ZONA 1



Dimensions	1 3/8" w x 1 1/2" h
Max Height	12 ft
Acoustics	35 STC
Glass Thickness	3/8", 1/2" or 5/8"
Glass Joints	Butt Glazed or Applied Sash

ZONA 1 +



Dimensions	2" w x 1 1/2" h
Max Height	12 ft
Acoustics	35 - 38 STC
Glass Thickness	3/8", 1/2" or 5/8"
Glass Joints	Butt Glazed, Mullions or Applied Sash

Perfect for sophisticated office settings or contemporary homes, **ZONA 1 and ZONA 1+** systems are premium single glazed solutions that redefine interior aesthetics.

Details

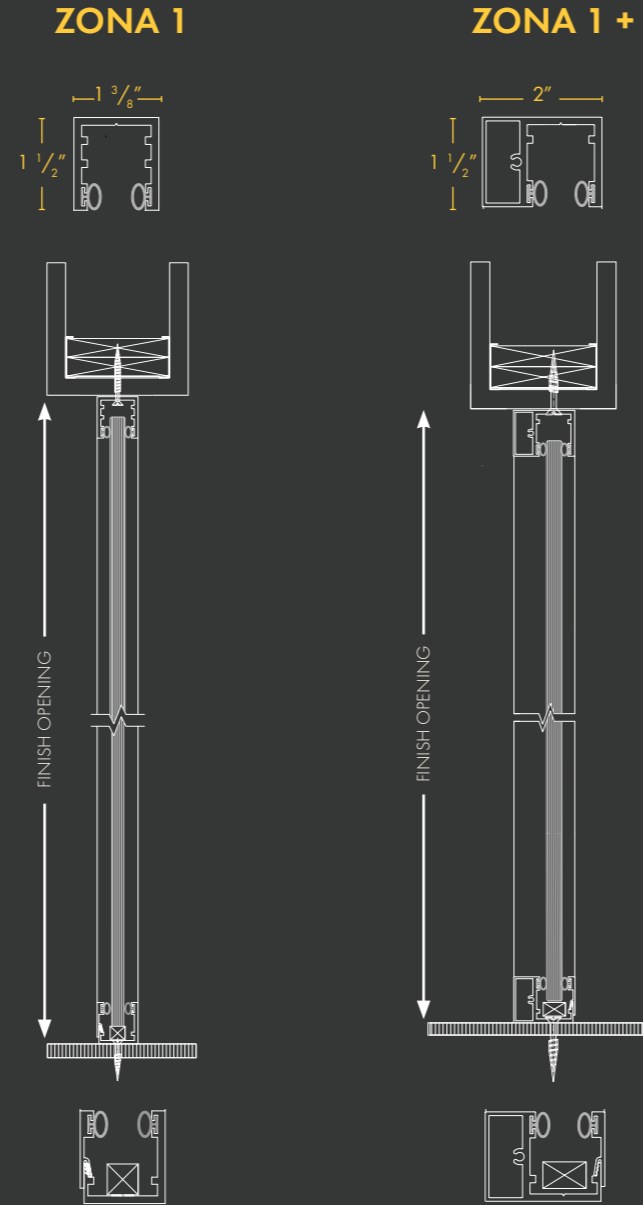

ZONA 2



Dimensions	3 1/4" w x 1 1/2" h
Max Height	12 ft
Acoustics	42 STC
Glass Thickness	3/8", 1/2" or 5/8"
Glass Joints	Butt Glazed or Mullions

ZONA 2 +



Dimensions*	4" w x 1 1/2" h
Max Height	12 ft
Acoustics	45 - 49 STC
Glass Thickness	3/8", 1/2" or 5/8"
Glass Joints	Butt Glazed or Mullions

* Custom airspace available

ZONA 2 and ZONA 2 + systems stand out as sophisticated double glazed glass walls that prioritize several key aspects in architectural design. These systems emphasize the crucial element of acoustics, ensuring a quiet and productive environment.

Details

ZONA 2

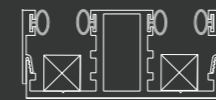
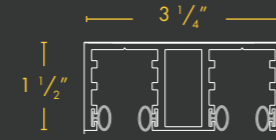

ZONA 2 +

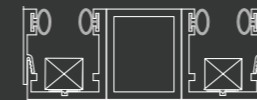
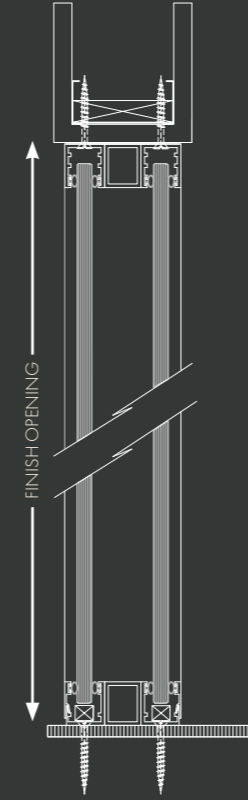
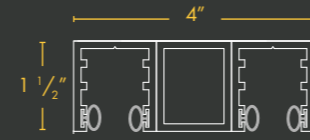

Door Styles

Whether you prefer sliding or swinging options, ZONA provides versatile and innovative solutions for glass doors that are compatible with all systems.

This flexibility can be quite beneficial, allowing for customization and compatibility with existing setups or future expansions.

Single Glazed



ZONA 1 DOOR

Door Thickness	1 1/4"
Glass Thickness	3/8"
Operation	Swing or Slide
Hardware	Locking, Non-Locking Pulls, Levers
Additional Options	Surface Mounted Closer



ZONA 1 + DOOR

Door Thickness	1 3/4"
Glass Thickness	3/8"
Operation	Swing
Hardware*	Pulls, Lockset & Lever
Additional Options	Concealed Closer, 1 Drop Seal

* Compatible with most hardware

Double Glazed



ZONA 2 DOOR

Door Thickness	2 1/4"
Glass Thickness	1/4" (2 layers)
Operation	Swing
Hardware	Pulls, Lockset & Lever
Additional Options	Concealed Closer, 2 Drop Seals

Specialty



WOOD DOOR

Door Thickness	1 3/4" Single Glazed or 2 1/4" Double Glazed
Operation	Swing
Hardware*	Pulls, Lockset & Levers
Additional Options	Concealed Closers, Drop Seals

* Compatible with most hardware



FRAMELESS DOOR

Door Thickness	1/2" or 5/8" Tempered
Operation	Swing
Hardware	Pulls, Lockset & Lever
Additional Options	Applied Drop Seals

Finishes

Standard Frame & Door Panel Finishes (AAMA 2604)



Also available in a wide array of custom powder coated RAL Colors and Anodized Finishes.

Glass Options

ZONA Glass Wall Systems can incorporate a variety of glass types to meet your specification.

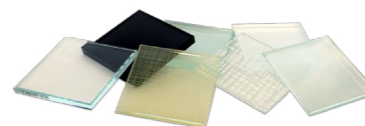

- Tempered
- Clear
- Laminated
- Low Iron
- Acoustic
- Specialty Glass

Hardware Options

ZONA also works with a variety of decorative and specialized hardware manufacturers to meet the requirements of every project. Contact our team to discuss available options.

- Locking/ Non-Locking Pulls
- Mortise/Cylindrical Locksets
- Maglocks/Electric Strikes
- Drop Seals
- Free Swing & Hydraulic Hinges
- Door Closers (Concealed/ Surface Applied)

Explore Exceptional Support & Resources

- Our team of experts are ready to help you plan your project, detail your space, and optimize your layout.
- Whether your project is big or small, our local sales, installation, and service professionals are there to help!
- Visit www.zonaglasswallsystems.com to discover the possibilities!



ZONA[®]

GLASS WALL SYSTEMS

ZONA Glass Wall Systems, Inc.

2099 Main Road, Newfield, NJ 08344

T: 201.329.6279

info@zonaglasswallsystems.com

www.zonaglasswallsystems.com

